

PROJECT	_____
TYPE	_____
SPECIFIER	_____
QUANTITY	_____
DATE	_____

## ZOE MONOPOINT SUSPENSION

**D141121-** \_\_\_\_\_ - \_\_\_\_\_  
 base number      Finish      Finish  
                          Options      Options

- To build a product code in our configurator select the specify button on the base model # product page
- To build a manual product code on this datasheet choose from the options listed below in blue font and add the suffix to the base model #

### GENERAL

Series: Zoe  
 Subseries: Zoe Monopoint  
 Partner: Cangini & Tucci  
 Division: Design  
 Installation: Suspension  
 Product Type: Pendant  
 Mounting Location: Ceiling

### PHYSICAL

Shape: Teardrop  
 Diameter (mm): 160  
 Diameter (in): 6 <sup>5</sup>/<sub>16</sub>  
 Height (mm): 280  
 Height (in): 11  
 Max. Overall Height (mm): 1780  
 Max. Overall Height (in): 70 <sup>7</sup>/<sub>16</sub>  
 Weight (kg): 0.79  
 Weight (lbs): 1.74  
 Diffuser: Glass - Opal  
 Fixture Finish: [AMB](#) / [BLK](#) / [BRZ](#) / [GLD](#) / [GRN](#) / [PNK](#) / [RUB](#) / [SKB](#) / [SMK](#) / [TOB](#) / [TRA](#)  
 Holder Finish: CHR / MWH / MBK / BCR  
 Fixture Material: Glass / Metal  
 Primary Material: Glass - Borosilicate  
 Cable Details: 1500mm cable

### ELECTRICAL

Number of Lamps: 1  
 Lamp Type: LED Retrofit  
 Bulb Included: Bulb Not Included  
 Max. Wattage Per Lamp (W): 5  
 Lamp Base: G9  
 Input Voltage (V): 120

### LED

### OPTICAL

### RATINGS AND CERTIFICATIONS

Certified By: Certified for North American Standards  
 IP rating: IP20

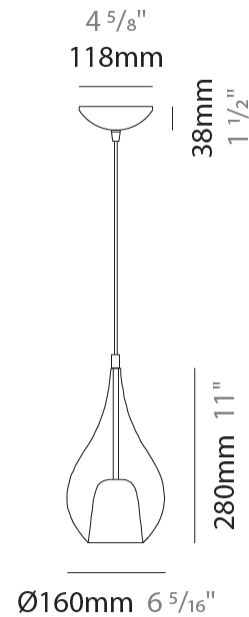

## ZOE MONOPOINT SUSPENSION

D141121-

PROJECT

TYPE

SPECIFIER

QUANTITY

DATE

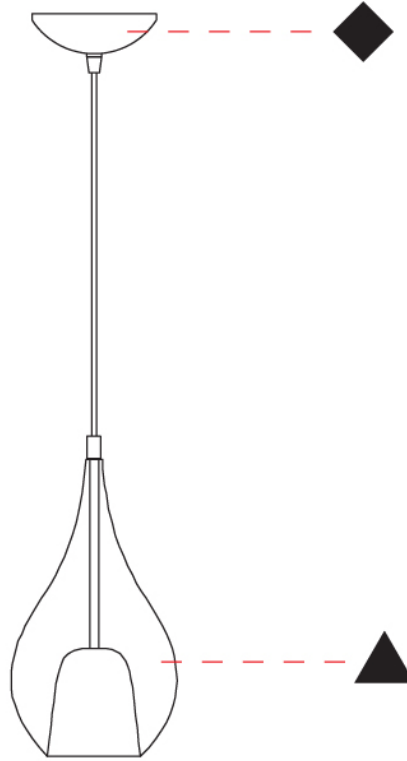

PROJECT	
TYPE	
SPECIFIER	
QUANTITY	
DATE	

## ZOE MONOPOINT SUSPENSION

**D141122-** -  
 base number      Finish Options      Finish Options

- To build a product code in our configurator select the specify button on the base model # product page
- To build a manual product code on this datasheet choose from the options listed below in blue font and add the suffix to the base model #

### GENERAL

Series: Zoe  
 Subseries: Zoe Monopoint  
 Partner: Cangini & Tucci  
 Division: Design  
 Installation: Suspension  
 Product Type: Pendant  
 Mounting Location: Ceiling

### PHYSICAL

Shape: Teardrop  
 Diameter (mm): 220  
 Diameter (in): 8 <sup>11</sup>/<sub>16</sub>  
 Height (mm): 380  
 Height (in): 14 <sup>15</sup>/<sub>16</sub>  
 Max. Overall Height (mm): 1880  
 Max. Overall Height (in): 74  
 Weight (kg): 1.51  
 Weight (lbs): 3.33  
 Diffuser: Glass - Opal  
 Fixture Finish: [AMB](#) / [BLK](#) / [BRZ](#) / [GLD](#) / [GRN](#) / [PNK](#) / [RUB](#) / [SKB](#) / [SMK](#) / [TOB](#) / [TRA](#)  
 Holder Finish: [CHR](#) / [MWH](#) / [MBK](#) / [BCR](#)  
 Fixture Material: Glass / Metal  
 Primary Material: Glass - Borosilicate  
 Cable Details: 1500mm cable

### ELECTRICAL

Number of Lamps: 1  
 Lamp Type: LED Retrofit  
 Lamp Shape: A19  
 Bulb Included: Bulb Not Included  
 Max. Wattage Per Lamp (W): 16  
 Lamp Base: E26  
 Input Voltage (V): 120  
 Upon Request: 277Vac / GU24

### LED

### OPTICAL

### RATINGS AND CERTIFICATIONS

Certified By: Certified for North American Standards  
 IP rating: IP20

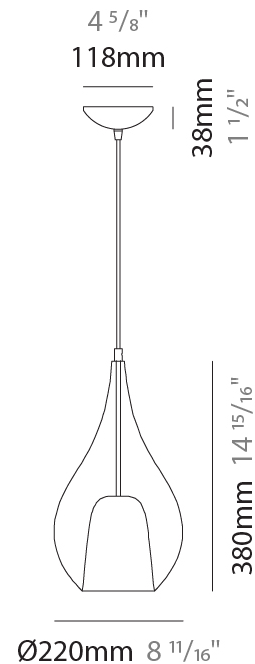

## ZOE MONOPOINT SUSPENSION

D141122-

PROJECT

TYPE

SPECIFIER

QUANTITY

DATE

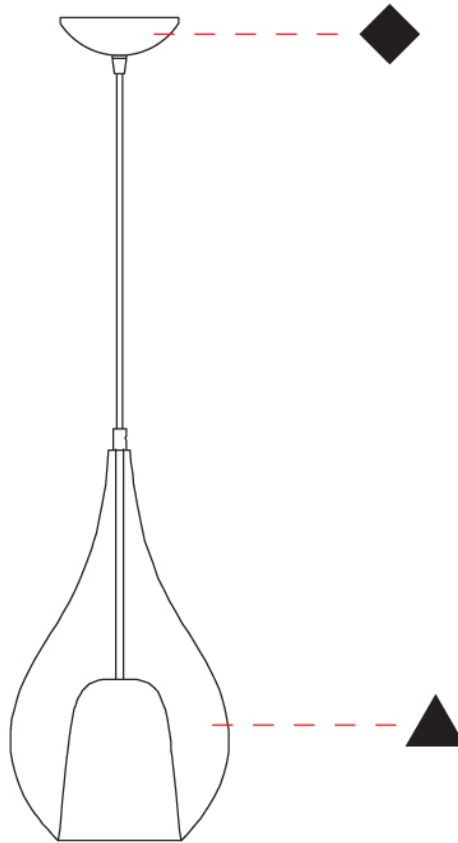

D

PROJECT	
TYPE	
SPECIFIER	
QUANTITY	
DATE	

## ZOE MONOPOINT SUSPENSION

### D141123-

base number      Finish Options      -      Finish Options

- To build a product code in our configurator select the specify button on the base model # product page
- To build a manual product code on this datasheet choose from the options listed below in blue font and add the suffix to the base model #

#### GENERAL

Series: Zoe  
 Subseries: Zoe Monopoint  
 Partner: Cangini & Tucci  
 Division: Design  
 Installation: Suspension  
 Product Type: Pendant  
 Mounting Location: Ceiling

#### PHYSICAL

Shape: Teardrop  
 Diameter (mm): 300  
 Diameter (in): 11 <sup>13</sup>/<sub>16</sub>  
 Height (mm): 530  
 Height (in): 20 <sup>7</sup>/<sub>8</sub>  
 Max. Overall Height (mm): 2030  
 Max. Overall Height (in): 79 <sup>15</sup>/<sub>16</sub>  
 Weight (kg): 2.50  
 Weight (lbs): 5.51  
 Diffuser: Glass - Opal  
 Fixture Finish: [AMB / BLK / BRZ / GLD / GRN / PNK / RUB / SKB / SMK / TOB / TRA](#)  
 Holder Finish: CHR / MWH / MBK / BCR  
 Fixture Material: Glass / Metal  
 Primary Material: Glass - Borosilicate  
 Cable Details: 1500mm Cable

#### ELECTRICAL

Number of Lamps: 1  
 Lamp Type: LED Retrofit  
 Lamp Shape: A19  
 Bulb Included: Bulb Not Included  
 Max. Wattage Per Lamp (W): 16  
 Lamp Base: E26  
 Input Voltage (V): 120  
 Upon Request: 277Vac / GU24

#### LED

#### OPTICAL

#### RATINGS AND CERTIFICATIONS

Certified By: Certified for North American Standards  
 IP rating: IP20

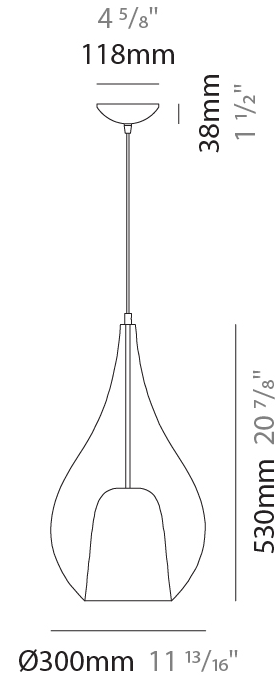

## ZOE MONOPOINT SUSPENSION

D141123-

PROJECT

TYPE

SPECIFIER

QUANTITY

DATE

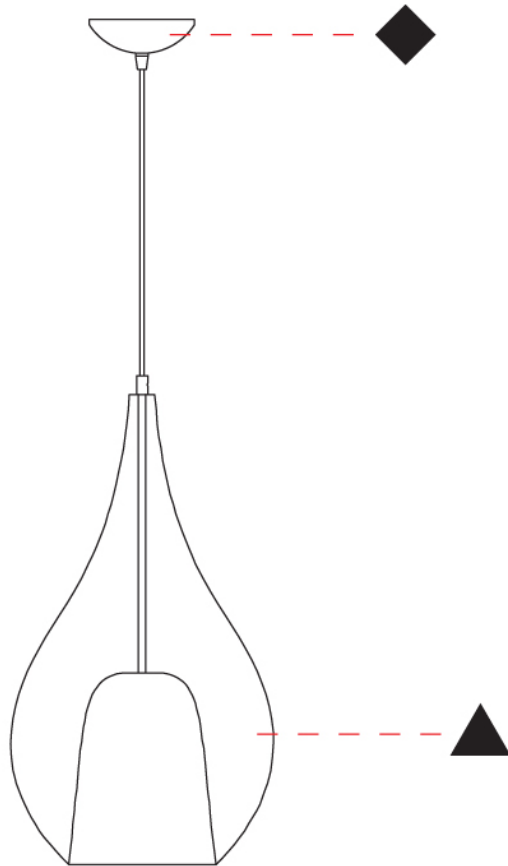

D

PROJECT	
TYPE	
SPECIFIER	
QUANTITY	
DATE	

## ZOE 2 LIGHT SWAG SUSPENSION

### D141127-

base number	Finish Options	Finish Options
-------------	----------------	----------------

- To build a product code in our configurator select the specify button on the base model # product page
- To build a manual product code on this datasheet choose from the options listed below in blue font and add the suffix to the base model #

#### GENERAL

Series: Zoe
Subseries: Zoe 2 Light Swag
Partner: Cangini & Tucci
Division: Design
Installation: Suspension
Product Type: Pendant
Mounting Location: Ceiling

#### PHYSICAL

Shape: Teardrop
Diameter (mm): 160
Diameter (in): 6 <sup>5</sup> / <sub>16</sub>
Height (mm): 280
Height (in): 11
Max. Overall Height (mm): 2280
Max. Overall Height (in): 89 <sup>3</sup> / <sub>4</sub>
Weight (kg): 1.53
Weight (lbs): 3.37
Diffuser: Glass - Opal
Fixture Finish: <a href="#">AMB</a> / <a href="#">BLK</a> / <a href="#">BRZ</a> / <a href="#">GLD</a> / <a href="#">GRN</a> / <a href="#">PNK</a> / <a href="#">RUB</a> / <a href="#">SKB</a> / <a href="#">SMK</a> / <a href="#">TOB</a> / <a href="#">TRA</a>
Holder Finish: <a href="#">CHR</a> / <a href="#">MWH</a> / <a href="#">MBK</a> / <a href="#">BCR</a>
Fixture Material: Glass / Metal
Primary Material: Glass - Borosilicate
Cable Details: 2000mm cable

#### ELECTRICAL

Number of Lamps: 2
Lamp Type: LED Retrofit
Bulb Included: Bulb Not Included
Total Output Wattage (W): 10
Max. Wattage Per Lamp (W): 5
Lamp Base: G9
Input Voltage (V): 120

#### LED

#### OPTICAL

#### RATINGS AND CERTIFICATIONS

Certified By: Certified for North American Standards
IP rating: IP20

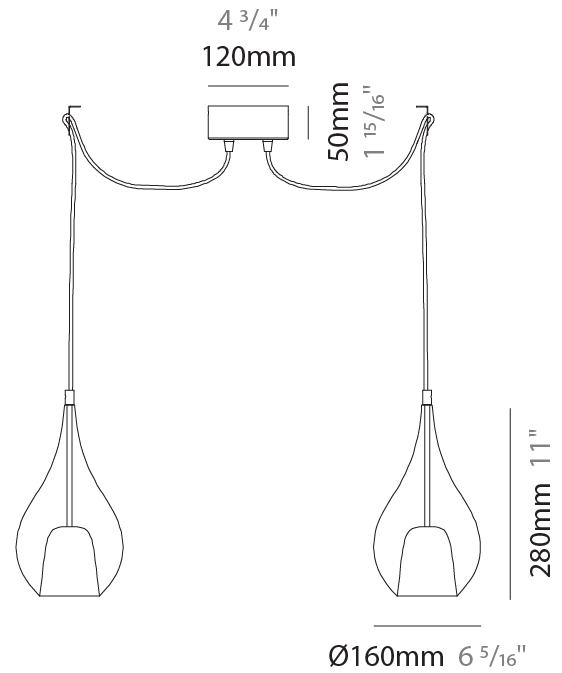

## ZOE 2 LIGHT SWAG SUSPENSION

D141127-

PROJECT	_____
TYPE	_____
SPECIFIER	_____
QUANTITY	_____
DATE	_____

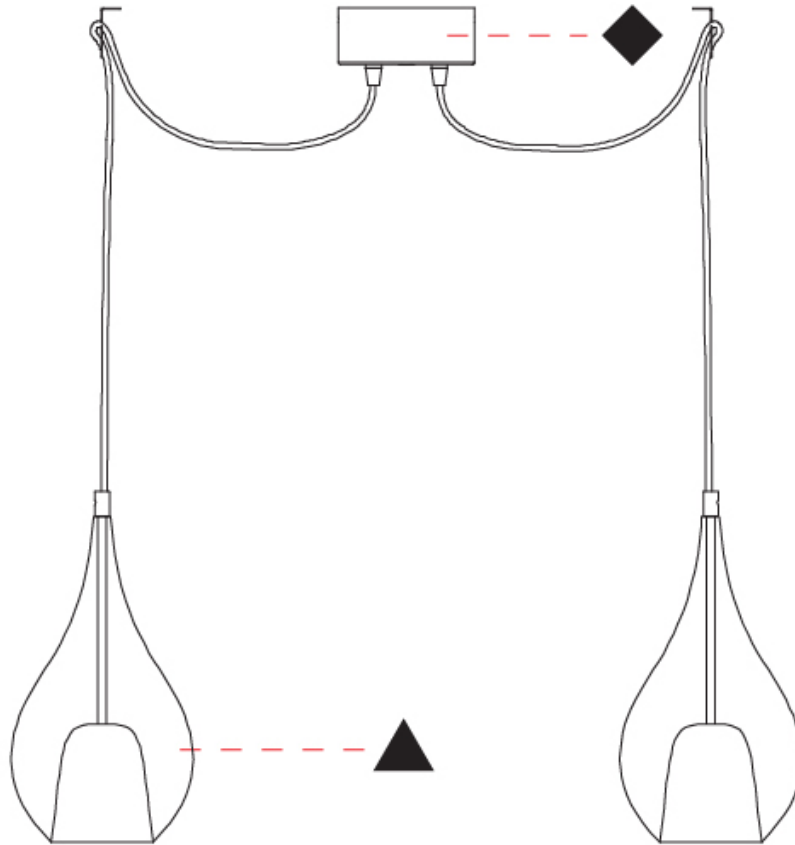

D

## ZOE 3 LIGHT SWAG SUSPENSION

### D141128-

base number      Finish      Finish  
 Options            Options

- To build a product code in our configurator select the specify button on the base model # product page
- To build a manual product code on this datasheet choose from the options listed below in blue font and add the suffix to the base model #

#### GENERAL

Series: Zoe  
 Subseries: Zoe 3 Light Swag  
 Partner: Cangini & Tucci  
 Division: Design  
 Installation: Suspension  
 Product Type: Pendant  
 Mounting Location: Ceiling

#### PHYSICAL

Shape: Teardrop  
 Diameter (mm): 160  
 Diameter (in): 6 <sup>5</sup>/<sub>16</sub>  
 Height (mm): 280  
 Height (in): 11  
 Max. Overall Height (mm): 2280  
 Max. Overall Height (in): 89 <sup>3</sup>/<sub>4</sub>  
 Weight (kg): 2.25  
 Weight (lbs): 4.96  
 Diffuser: Glass - Opal  
 Fixture Finish: [AMB](#) / [BLK](#) / [BRZ](#) / [GLD](#) / [GRN](#) / [PNK](#) / [RUB](#) / [SKB](#) / [SMK](#) / [TOB](#) / [TRA](#)  
 Holder Finish: [CHR](#) / [MWH](#) / [MBK](#) / [BCR](#)  
 Fixture Material: Glass / Metal  
 Primary Material: Glass - Borosilicate  
 Cable Details: 2000mm cable

#### ELECTRICAL

Number of Lamps: 3  
 Lamp Type: LED Retrofit  
 Bulb Included: Bulb Not Included  
 Total Output Wattage (W): 15  
 Max. Wattage Per Lamp (W): 5  
 Lamp Base: G9  
 Input Voltage (V): 120

#### LED

#### OPTICAL

#### RATINGS AND CERTIFICATIONS

Certified By: Certified for North American Standards  
 IP rating: IP20

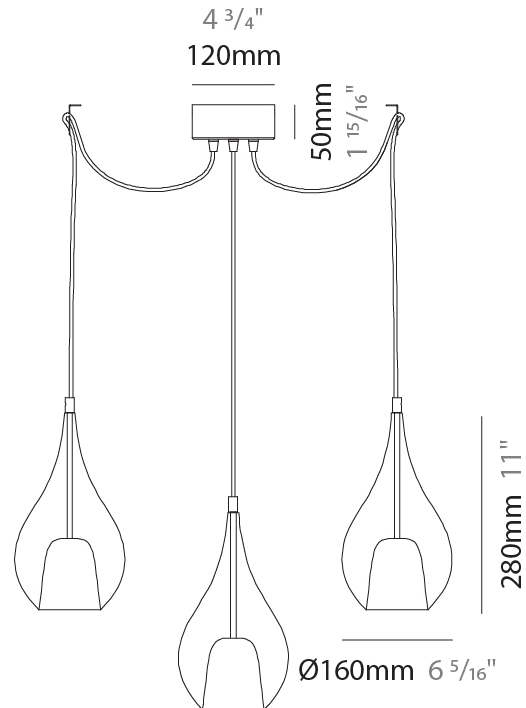

## ZOE 3 LIGHT SWAG SUSPENSION

D141128-

PROJECT	_____
TYPE	_____
SPECIFIER	_____
QUANTITY	_____
DATE	_____

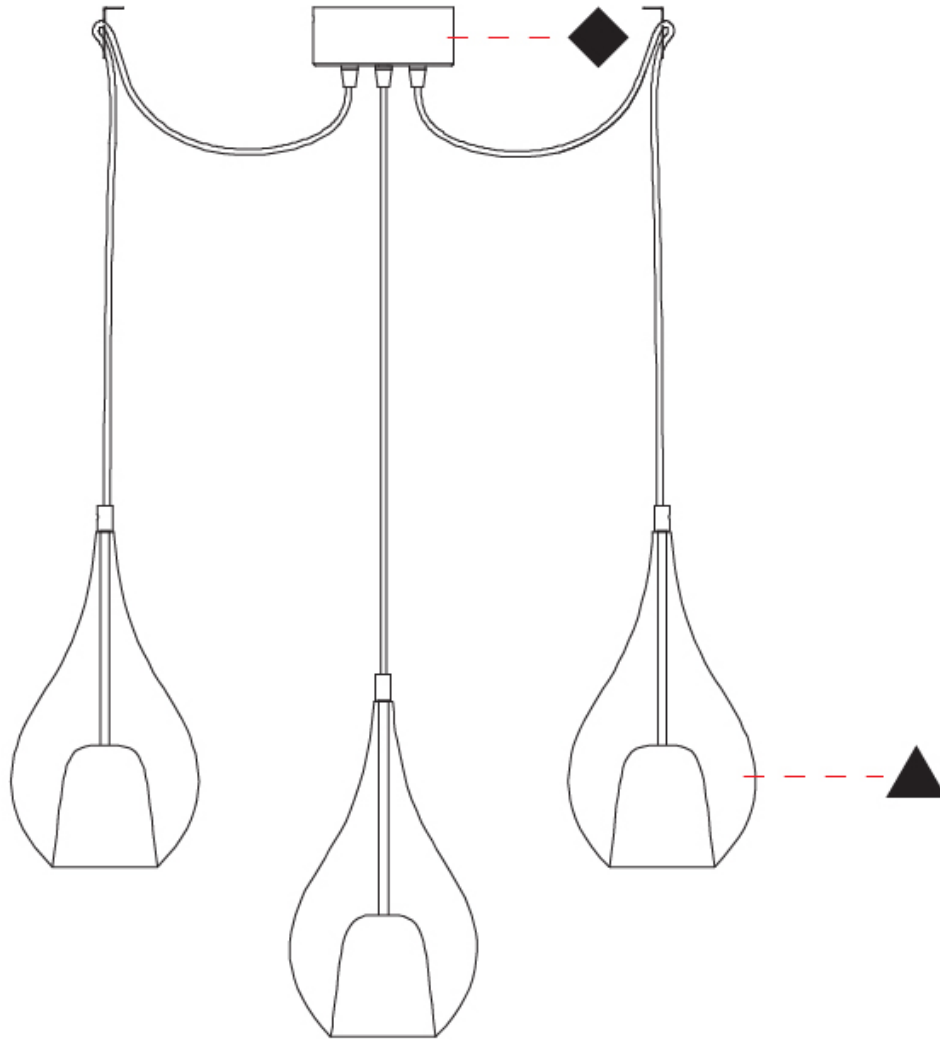

D

PROJECT	_____
TYPE	_____
SPECIFIER	_____
QUANTITY	_____
DATE	_____

## ZOE 2 LIGHT SWAG SUSPENSION

### D141129-

base number	Finish Options	Finish Options
-------------	----------------	----------------

- To build a product code in our configurator select the specify button on the base model # product page
- To build a manual product code on this datasheet choose from the options listed below in blue font and add the suffix to the base model #

#### GENERAL

Series: Zoe
Subseries: Zoe 2 Light Swag
Partner: Cangini & Tucci
Division: Design
Installation: Suspension
Product Type: Pendant
Mounting Location: Ceiling

#### PHYSICAL

Shape: Teardrop
Diameter (mm): 220
Diameter (in): 8 <sup>11</sup> / <sub>16</sub>
Height (mm): 380
Height (in): 14 <sup>15</sup> / <sub>16</sub>
Max. Overall Height (mm): 2380
Max. Overall Height (in): 93 <sup>11</sup> / <sub>16</sub>
Weight (kg): 2.81
Weight (lbs): 6.19
Diffuser: Glass - Opal
Fixture Finish: <a href="#">AMB</a> / <a href="#">BLK</a> / <a href="#">BRZ</a> / <a href="#">GLD</a> / <a href="#">GRN</a> / <a href="#">PNK</a> / <a href="#">RUB</a> / <a href="#">SKB</a> / <a href="#">SMK</a> / <a href="#">TOB</a> / <a href="#">TRA</a>
Holder Finish: CHR / MWH / MBK / BCR
Fixture Material: Glass / Metal
Primary Material: Glass - Borosilicate
Cable Details: 2000mm cable

#### ELECTRICAL

Number of Lamps: 2
Lamp Type: LED Retrofit
Lamp Shape: A19
Bulb Included: Bulb Not Included
Total Output Wattage (W): 32
Max. Wattage Per Lamp (W): 16
Lamp Base: E26
Input Voltage (V): 120
Upon Request: 277Vac / GU24

#### LED

#### OPTICAL

#### RATINGS AND CERTIFICATIONS

Certified By: Certified for North American Standards
IP rating: IP20

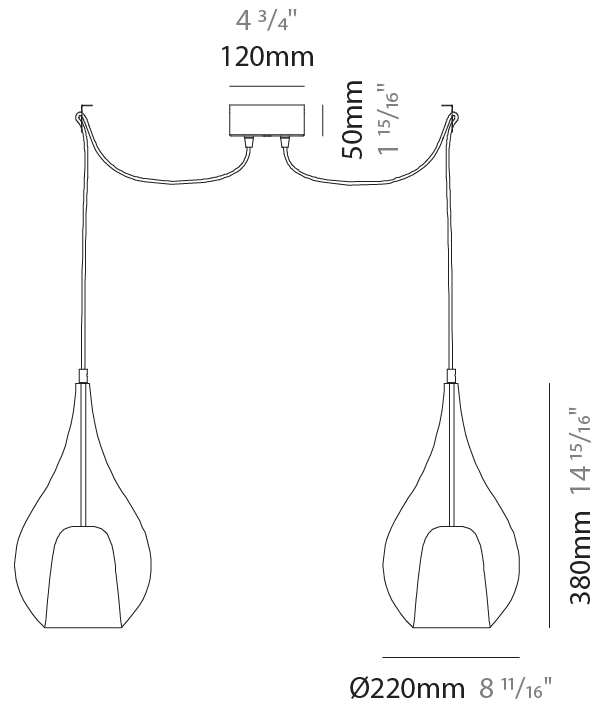

## ZOE 2 LIGHT SWAG SUSPENSION

D141129-

PROJECT	_____
TYPE	_____
SPECIFIER	_____
QUANTITY	_____
DATE	_____

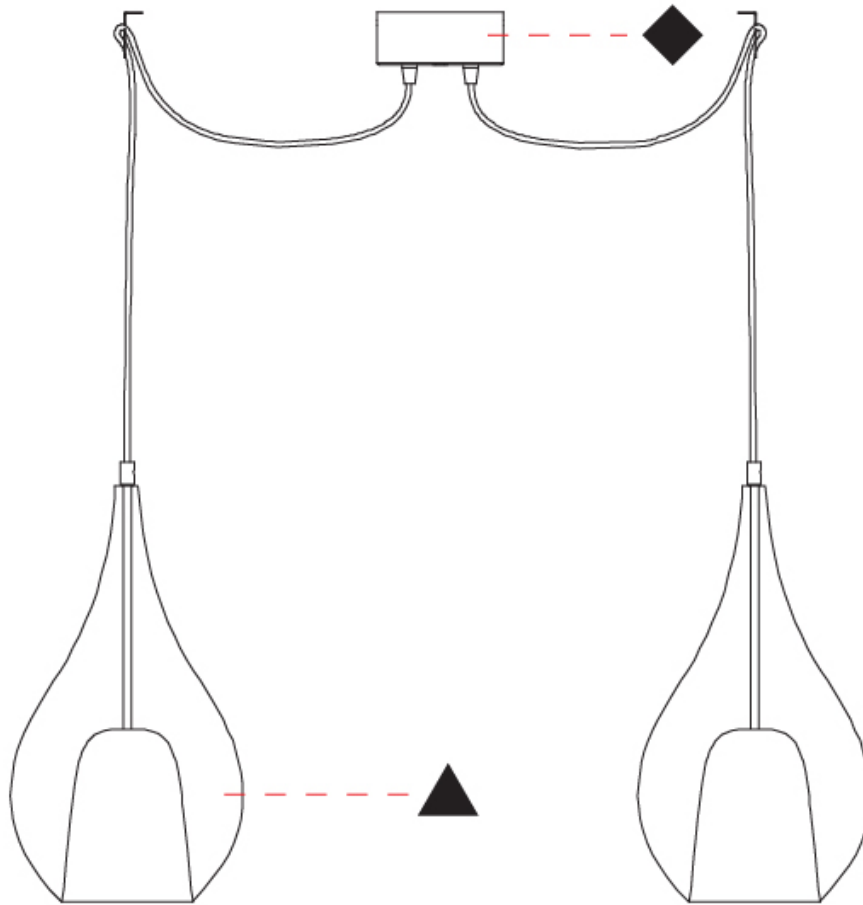

D

PROJECT	
TYPE	
SPECIFIER	
QUANTITY	
DATE	

## ZOE 2 LIGHT SWAG SUSPENSION

### D141130-

base number      Finish Options      Finish Options

- To build a product code in our configurator select the specify button on the base model # product page
- To build a manual product code on this datasheet choose from the options listed below in blue font and add the suffix to the base model #

#### GENERAL

Series: Zoe  
 Subseries: Zoe 2 Light Swag  
 Partner: Cangini & Tucci  
 Division: Design  
 Installation: Suspension  
 Product Type: Pendant  
 Mounting Location: Ceiling

#### PHYSICAL

Shape: Teardrop  
 Diameter (mm): 300  
 Diameter (in): 11 <sup>13</sup>/<sub>16</sub>  
 Height (mm): 530  
 Height (in): 20 <sup>7</sup>/<sub>8</sub>  
 Max. Overall Height (mm): 2530  
 Max. Overall Height (in): 99 <sup>5</sup>/<sub>8</sub>  
 Weight (kg): 4.8  
 Weight (lbs): 10.58  
 Diffuser: Glass - Opal  
 Fixture Finish: [AMB / BLK / BRZ / GLD / GRN / PNK / RUB / SKB / SMK / TOB / TRA](#)  
 Holder Finish: CHR / MWH / MBK / BCR  
 Fixture Material: Glass / Metal  
 Primary Material: Glass - Borosilicate  
 Cable Details: 2000mm cable

#### ELECTRICAL

Number of Lamps: 2  
 Lamp Type: LED Retrofit  
 Lamp Shape: A19  
 Bulb Included: Bulb Not Included  
 Total Output Wattage (W): 32  
 Max. Wattage Per Lamp (W): 16  
 Lamp Base: E26  
 Input Voltage (V): 120  
 Upon Request: 277Vac / GU24

#### LED

#### OPTICAL

#### RATINGS AND CERTIFICATIONS

Certified By: Certified for North American Standards  
 IP rating: IP20

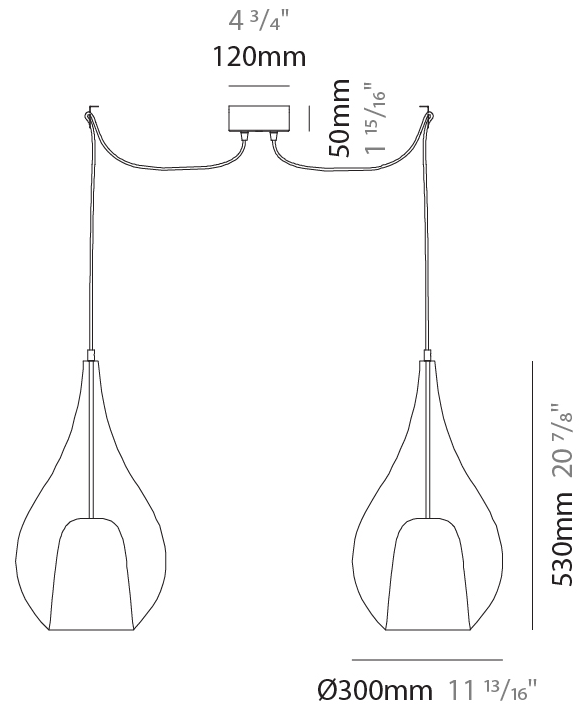

## ZOE 2 LIGHT SWAG SUSPENSION

D141130-

PROJECT	_____
TYPE	_____
SPECIFIER	_____
QUANTITY	_____
DATE	_____

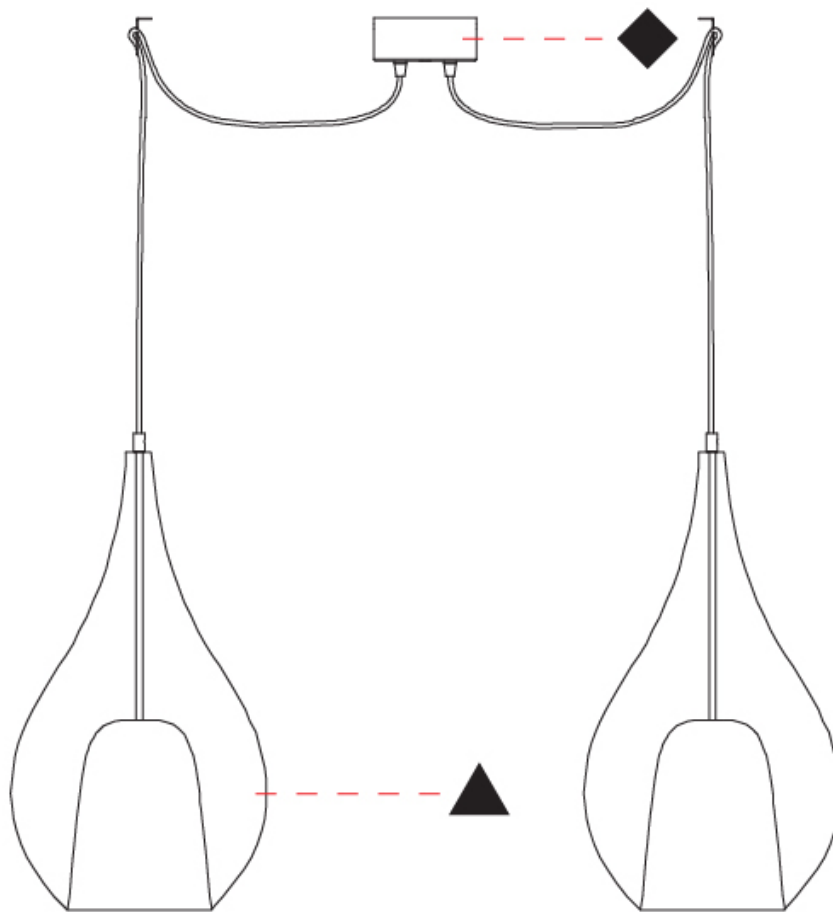

D

PROJECT
TYPE
SPECIFIER
QUANTITY
DATE

## ZOE 3 LIGHT LINEAR SUSPENSION

**D141131-** -  
 base number      Finish      Finish  
                          Options      Options

- To build a product code in our configurator select the specify button on the base model # product page
- To build a manual product code on this datasheet choose from the options listed below in blue font and add the suffix to the base model #

### GENERAL

Series: Zoe  
 Subseries: Zoe 3 Light Linear  
 Partner: Cangini & Tucci  
 Division: Design  
 Installation: Suspension  
 Product Type: Pendant  
 Mounting Location: Ceiling

### PHYSICAL

Shape: Teardrop  
 Length (mm): 1000  
 Length (in): 39 3/8  
 Height (mm): 280  
 Height (in): 11  
 Max. Overall Height (mm): 1780  
 Max. Overall Height (in): 70 1/16  
 Weight (kg): 2.90  
 Weight (lbs): 6.39  
 Diffuser: Glass - Opal  
 Fixture Finish: [AMB](#) / [BLK](#) / [BRZ](#) / [GLD](#) / [GRN](#) / [PNK](#) / [RUB](#) / [SKB](#) / [SMK](#) / [TOB](#) / [TRA](#)  
 Holder Finish: [CHR](#) / [MWH](#) / [MBK](#) / [BCR](#)  
 Fixture Material: Glass / Metal  
 Primary Material: Glass - Borosilicate  
 Cable Details: 1500mm cable

### ELECTRICAL

Number of Lamps: 3  
 Lamp Type: LED Retrofit  
 Bulb Included: Bulb Not Included  
 Total Output Wattage (W): 15  
 Max. Wattage Per Lamp (W): 5  
 Lamp Base: G9  
 Input Voltage (V): 120

### LED

### OPTICAL

### RATINGS AND CERTIFICATIONS

Certified By: Certified for North American Standards  
 IP rating: IP20

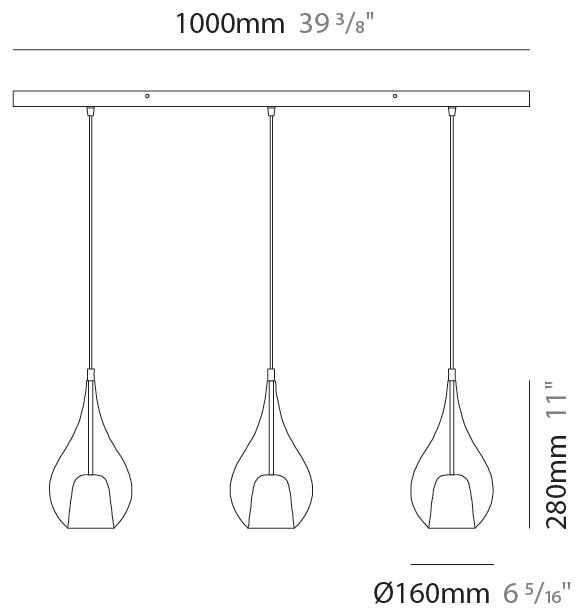

## ZOE 3 LIGHT LINEAR SUSPENSION

D141131-

PROJECT	_____
TYPE	_____
SPECIFIER	_____
QUANTITY	_____
DATE	_____

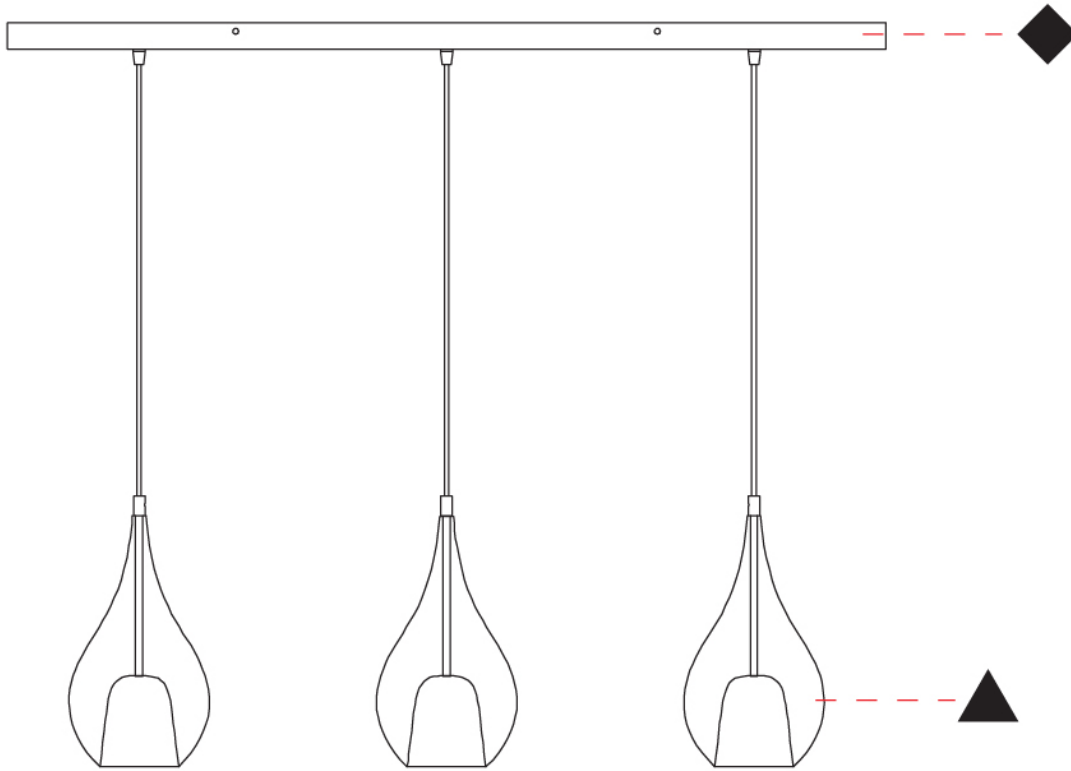

D

PROJECT
TYPE
SPECIFIER
QUANTITY
DATE

## ZOE 3 LIGHT LINEAR SUSPENSION

### D141132-

base number      Finish Options      Finish Options

- To build a product code in our configurator select the specify button on the base model # product page
- To build a manual product code on this datasheet choose from the options listed below in blue font and add the suffix to the base model #

#### GENERAL

Series: Zoe  
 Subseries: Zoe 3 Light Linear  
 Partner: Cangini & Tucci  
 Division: Design  
 Installation: Suspension  
 Product Type: Pendant  
 Mounting Location: Ceiling

#### PHYSICAL

Shape: Teardrop  
 Length (mm): 1200  
 Length (in): 47 1/4  
 Height (mm): 280  
 Height (in): 11  
 Max. Overall Height (mm): 1780  
 Max. Overall Height (in): 70 7/16  
 Weight (kg): 5.59  
 Weight (lbs): 12.32  
 Diffuser: Glass - Opal  
 Fixture Finish: [AMB](#) / [BLK](#) / [BRZ](#) / [GLD](#) / [GRN](#) / [PNK](#) / [RUB](#) / [SKB](#) / [SMK](#) / [TOB](#) / [TRA](#)  
 Holder Finish: [CHR](#) / [MWH](#) / [MBK](#) / [BCR](#)  
 Fixture Material: Glass / Metal  
 Primary Material: Glass - Borosilicate  
 Cable Details: 1500mm cable

#### ELECTRICAL

Number of Lamps: 3  
 Lamp Type: LED Retrofit  
 Lamp Shape: A19  
 Bulb Included: Bulb Not Included  
 Total Output Wattage (W): 48  
 Max. Wattage Per Lamp (W): 16  
 Lamp Base: E26  
 Input Voltage (V): 120  
 Upon Request: 277Vac / GU24

#### LED

#### OPTICAL

#### RATINGS AND CERTIFICATIONS

Certified By: Certified for North American Standards  
 IP rating: IP20

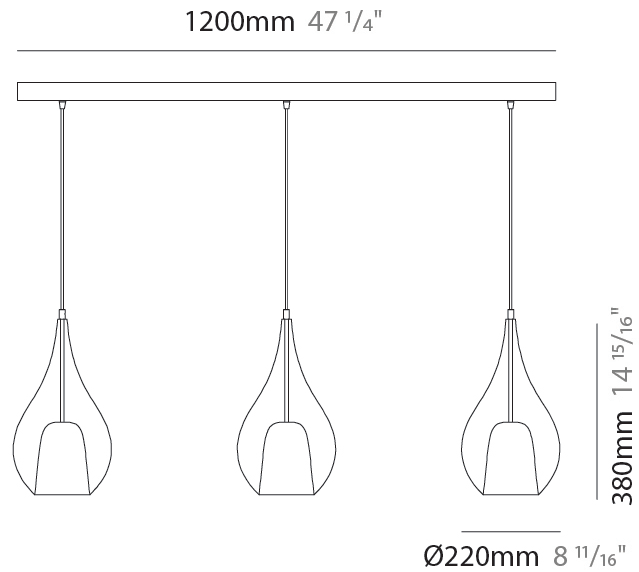

## ZOE 3 LIGHT LINEAR SUSPENSION

D141132-

PROJECT	_____
TYPE	_____
SPECIFIER	_____
QUANTITY	_____
DATE	_____

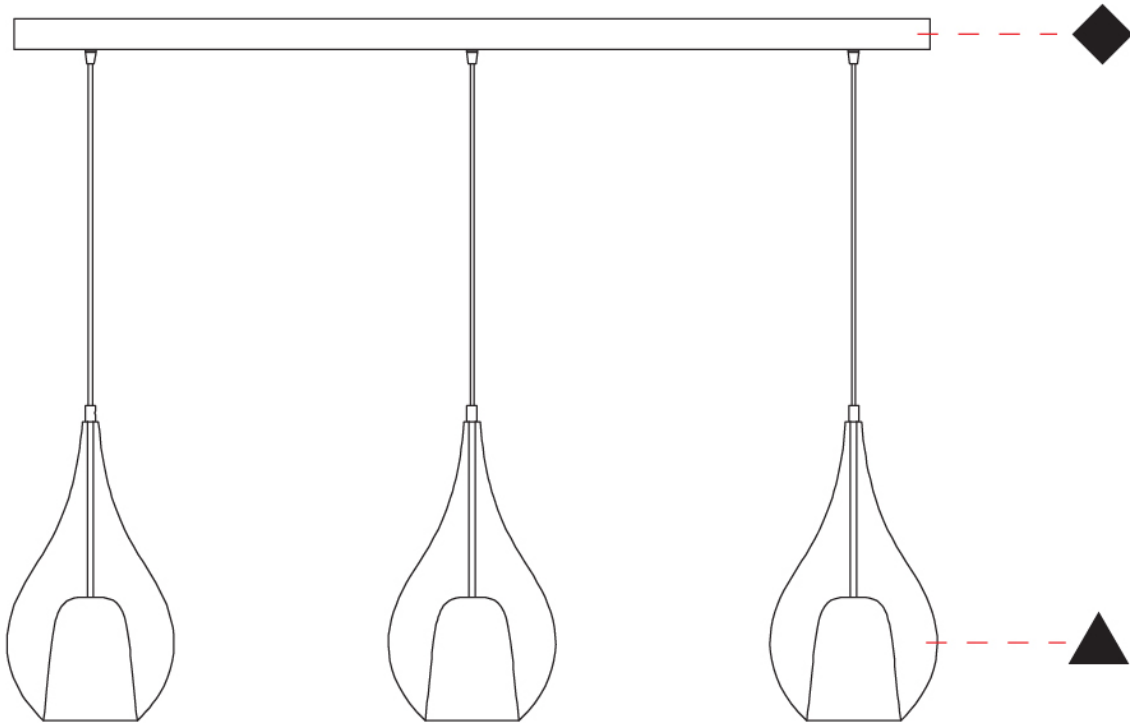

D

PROJECT
TYPE
SPECIFIER
QUANTITY
DATE

## ZOE 3 LIGHT CLUSTER SUSPENSION

### D141133-

base number      Finish Options      -      Finish Options

- To build a product code in our configurator select the specify button on the base model # product page
- To build a manual product code on this datasheet choose from the options listed below in blue font and add the suffix to the base model #

#### GENERAL

Series: Zoe  
 Subseries: Zoe 3 Light Cluster  
 Partner: Cangini & Tucci  
 Division: Design  
 Installation: Suspension  
 Product Type: Pendant  
 Mounting Location: Ceiling

#### PHYSICAL

Shape: Teardrop  
 Diameter (mm): 430  
 Diameter (in): 16 <sup>15</sup>/<sub>16</sub>  
 Height (mm): 1500  
 Height (in): 59 <sup>15</sup>/<sub>16</sub>  
 Weight (kg): 6.48  
 Weight (lbs): 14.29  
 Diffuser: Glass - Opal  
 Fixture Finish: [AMB](#) / [BLK](#) / [BRZ](#) / [GLD](#) / [GRN](#) / [PNK](#) / [RUB](#) / [SKB](#) / [SMK](#) / [TOB](#) / [TRA](#)  
 Holder Finish: [CHR](#) / [MWH](#) / [MBK](#) / [BCR](#)  
 Fixture Material: Glass / Metal  
 Primary Material: Glass - Borosilicate  
 Cable Details: 1500mm cable

#### ELECTRICAL

Number of Lamps: 3  
 Lamp Type: LED Retrofit  
 Bulb Included: Bulb Not Included  
 Total Output Wattage (W): 37  
 Max. Wattage Per Lamp (W): 16 + 5  
 Lamp Base: E26 + G9  
 Input Voltage (V): 120

#### LED

#### OPTICAL

#### RATINGS AND CERTIFICATIONS

Certified By: Certified for North American Standards  
 IP rating: IP20

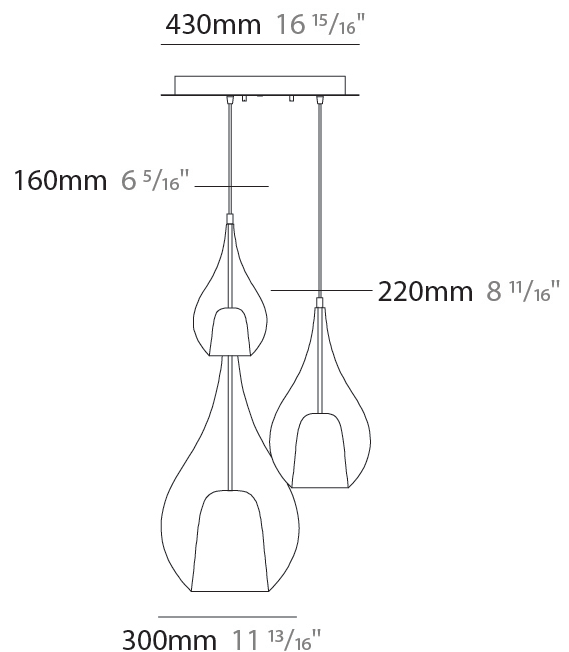

## ZOE 3 LIGHT CLUSTER SUSPENSION

D141133-

PROJECT	_____
TYPE	_____
SPECIFIER	_____
QUANTITY	_____
DATE	_____

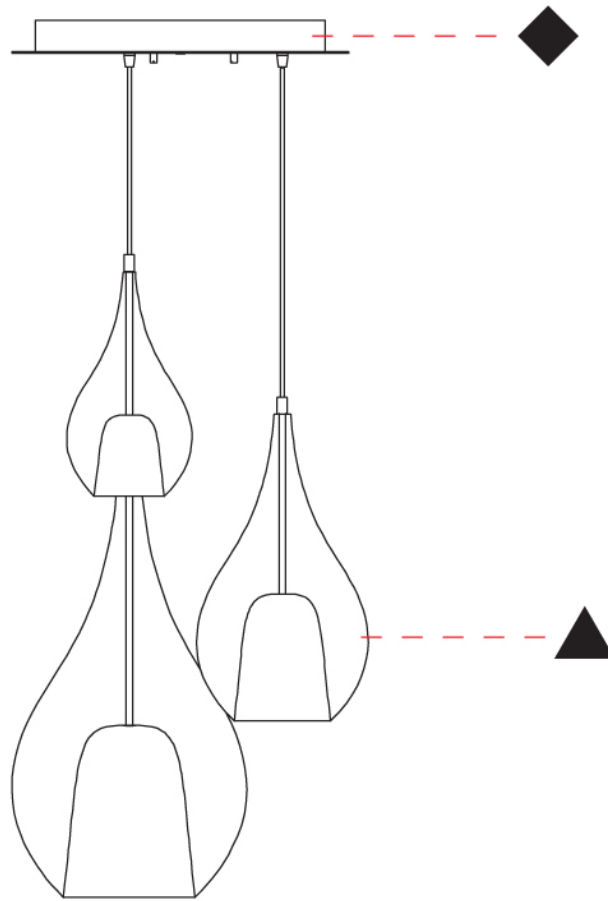

D

PROJECT	
TYPE	
SPECIFIER	
QUANTITY	
DATE	

## ZOE VINCENT - MONOPOINT SUSPENSION

### D141177-

base number                      Finish                       
Options                     

- To build a product code in our configurator select the specify button on the base model # product page
- To build a manual product code on this datasheet choose from the options listed below in blue font and add the suffix to the base model #

#### GENERAL

Series: Zoe                       
 Subseries: Zoe Vincent - Monopoint                       
 Partner: Cangini & Tucci                       
 Division: Design                       
 Installation: Suspension                       
 Product Type: Pendant                       
 Mounting Location: Ceiling                     

#### PHYSICAL

Shape: Teardrop                       
 Diameter (mm): 160                       
 Diameter (in): 6 <sup>5</sup>/<sub>16</sub>                       
 Height (mm): 280                       
 Height (in): 11                       
 Max. Overall Height (mm): 1780                       
 Max. Overall Height (in): 70 <sup>7</sup>/<sub>16</sub>                       
 Weight (kg): 0.79                       
 Weight (lbs): 1.74                       
 Diffuser: Glass - Opal                       
 Fixture Finish: [MSB / MBS / TRS](#)                       
 Holder Finish: BLK                       
 Fixture Material: Glass / Metal                       
 Primary Material: Glass - Borosilicate                       
 Cable Details: 1500mm cable                     

#### ELECTRICAL

Number of Lamps: 1                       
 Lamp Type: LED Retrofit                       
 Bulb Included: Bulb Not Included                       
 Max. Wattage Per Lamp (W): 5                       
 Lamp Base: G9                       
 Input Voltage (V): 120                     

#### LED

#### OPTICAL

#### RATINGS AND CERTIFICATIONS

Certified By: Certified for North American Standards                       
 IP rating: IP20                     

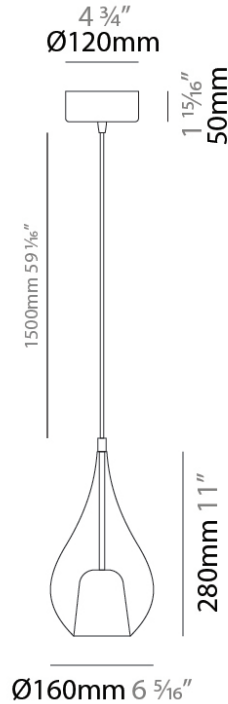

## ZOE VINCENT - MONOPOINT SUSPENSION

D141177-

PROJECT

TYPE

SPECIFIER

QUANTITY

DATE

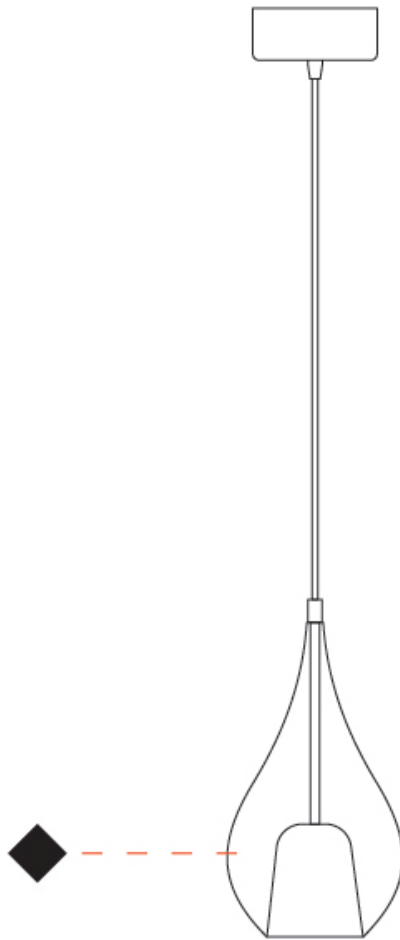

D

PROJECT	_____
TYPE	_____
SPECIFIER	_____
QUANTITY	_____
DATE	_____

## ZOE VINCENT - MONOPOINT SUSPENSION

### D141178-

base number            Finish             
Options           

- To build a product code in our configurator select the specify button on the base model # product page
- To build a manual product code on this datasheet choose from the options listed below in blue font and add the suffix to the base model #

#### GENERAL

Series: Zoe             
 Subseries: Zoe Vincent - Monopoint             
 Partner: Cangini & Tucci             
 Division: Design             
 Installation: Suspension             
 Product Type: Pendant             
 Mounting Location: Ceiling           

#### PHYSICAL

Shape: Teardrop             
 Diameter (mm): 220             
 Diameter (in): 8 11/16             
 Height (mm): 380             
 Height (in): 14 15/16             
 Max. Overall Height (mm): 1880             
 Max. Overall Height (in): 74             
 Weight (kg): 1.51             
 Weight (lbs): 3.33             
 Diffuser: Glass - Opal             
 Fixture Finish: MSB / MBS / TRS             
 Holder Finish: BLK             
 Fixture Material: Glass / Metal             
 Primary Material: Glass - Borosilicate             
 Cable Details: 1500mm cable           

#### ELECTRICAL

Number of Lamps: 1             
 Lamp Type: LED Retrofit             
 Lamp Shape: A19             
 Bulb Included: Bulb Not Included             
 Max. Wattage Per Lamp (W): 16             
 Lamp Base: E26             
 Input Voltage (V): 120             
 Upon Request: 277Vac / GU24           

#### LED

#### OPTICAL

#### RATINGS AND CERTIFICATIONS

Certified By: Certified for North American Standards             
 IP rating: IP20           

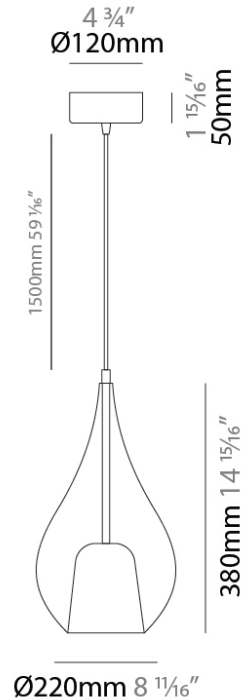

## ZOE VINCENT - MONOPOINT SUSPENSION

D141178-

PROJECT

TYPE

SPECIFIER

QUANTITY

DATE

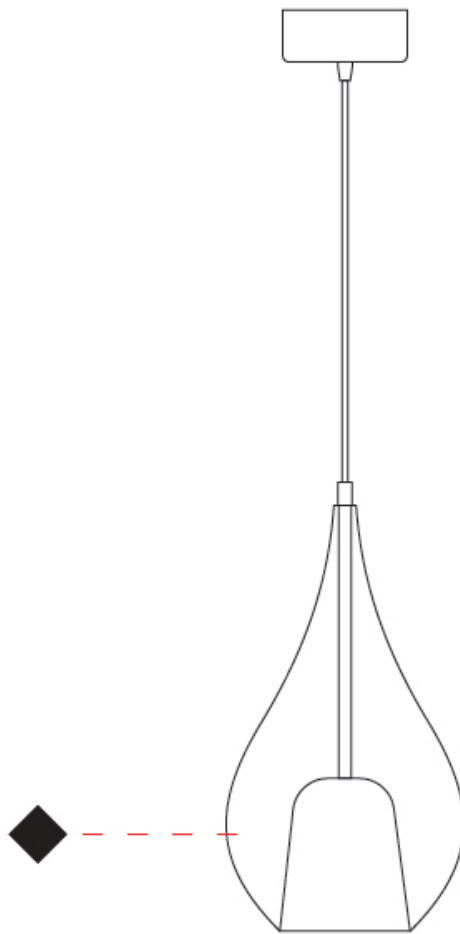

D

PROJECT
TYPE
SPECIFIER
QUANTITY
DATE

## ZOE VINCENT - MONOPOINT SUSPENSION

### D141179-

base number            Finish             
Options           

- To build a product code in our configurator select the specify button on the base model # product page
- To build a manual product code on this datasheet choose from the options listed below in blue font and add the suffix to the base model #

#### GENERAL

Series: Zoe             
 Subseries: Zoe Vincent - Monopoint             
 Partner: Cangani & Tucci             
 Division: Design             
 Installation: Suspension             
 Product Type: Pendant             
 Mounting Location: Ceiling           

#### PHYSICAL

Shape: Teardrop             
 Diameter (mm): 300             
 Diameter (in): 11 <sup>13</sup>/<sub>16</sub>             
 Height (mm): 530             
 Height (in): 20 <sup>7</sup>/<sub>8</sub>             
 Max. Overall Height (mm): 2030             
 Max. Overall Height (in): 79 <sup>15</sup>/<sub>16</sub>             
 Weight (kg): 2.50             
 Weight (lbs): 5.51             
 Diffuser: Glass - Opal             
 Fixture Finish: MSB / MBS / TRS             
 Holder Finish: BLK             
 Fixture Material: Glass / Metal             
 Primary Material: Glass - Borosilicate             
 Cable Details: 1500mm Cable           

#### ELECTRICAL

Number of Lamps: 1             
 Lamp Type: LED Retrofit             
 Lamp Shape: A19             
 Bulb Included: Bulb Not Included             
 Max. Wattage Per Lamp (W): 16             
 Lamp Base: E26             
 Input Voltage (V): 120             
 Upon Request: 277Vac / GU24           

#### LED

#### OPTICAL

#### RATINGS AND CERTIFICATIONS

Certified By: Certified for North American Standards             
 IP rating: IP20           

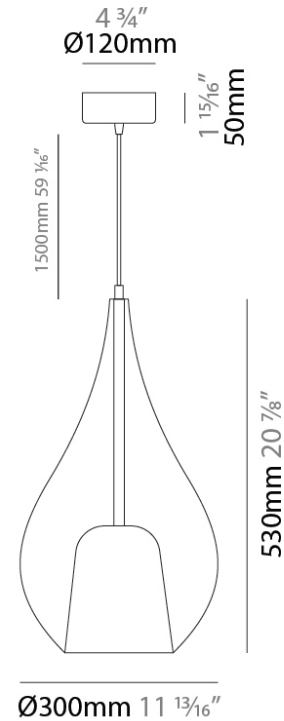

## ZOE VINCENT - MONOPOINT SUSPENSION

D141179-

PROJECT

TYPE

SPECIFIER

QUANTITY

DATE

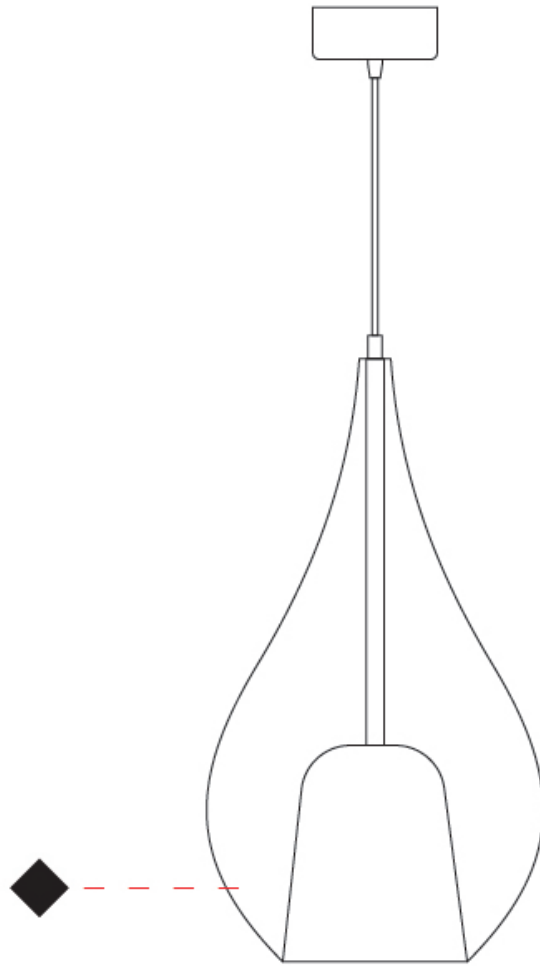

D

PROJECT
TYPE
SPECIFIER
QUANTITY
DATE

## ZOE VINCENT 3 LIGHT LINEAR SUSPENSION

### D141249-

base number Finish  
Options

- To build a product code in our configurator select the specify button on the base model # product page
- To build a manual product code on this datasheet choose from the options listed below in blue font and add the suffix to the base model #

#### GENERAL

Series: Zoe  
 Subseries: Zoe Vincent 3 Light Linear  
 Partner: Cangini & Tucci  
 Division: Design  
 Installation: Suspension  
 Product Type: Pendant  
 Mounting Location: Ceiling

#### PHYSICAL

Shape: Teardrop  
 Length (mm): 1000  
 Length (in): 39 <sup>3</sup>/<sub>8</sub>  
 Height (mm): 280  
 Height (in): 11  
 Max. Overall Height (mm): 1780  
 Max. Overall Height (in): 70 <sup>7</sup>/<sub>16</sub>  
 Weight (kg): 2.90  
 Weight (lbs): 6.39  
 Diffuser: Glass - Opal  
 Fixture Finish: [MSB / MBS / TRS](#)  
 Holder Finish: BLK  
 Fixture Material: Glass / Metal  
 Primary Material: Glass - Borosilicate  
 Cable Details: 1500mm cable

#### ELECTRICAL

Number of Lamps: 3  
 Lamp Type: LED Retrofit  
 Bulb Included: Bulb Not Included  
 Total Output Wattage (W): 15  
 Max. Wattage Per Lamp (W): 5  
 Lamp Base: G9  
 Input Voltage (V): 120

#### LED

#### OPTICAL

#### RATINGS AND CERTIFICATIONS

Certified By: Certified for North American Standards  
 IP rating: IP20

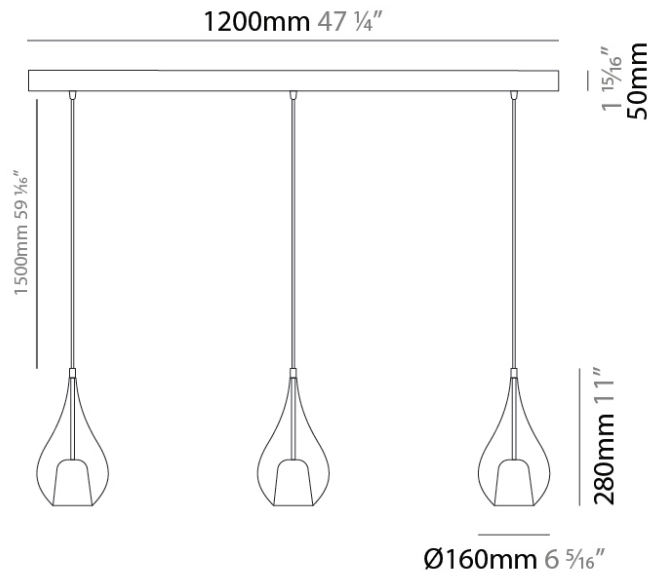

## ZOE VINCENT 3 LIGHT LINEAR SUSPENSION

D141249-

PROJECT	_____
TYPE	_____
SPECIFIER	_____
QUANTITY	_____
DATE	_____

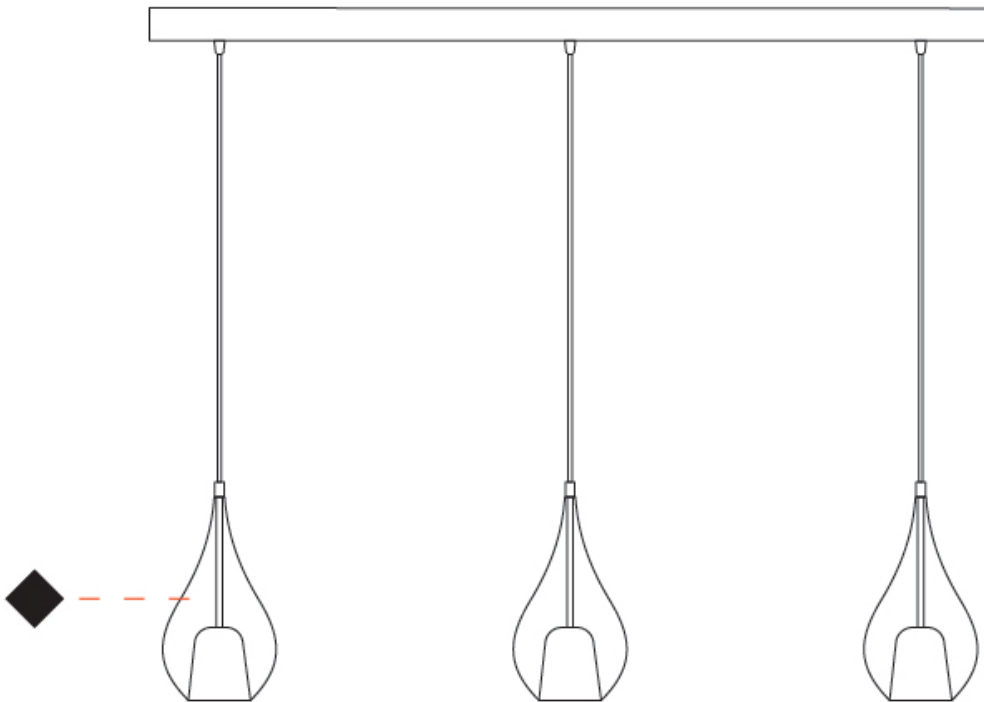

D

PROJECT
TYPE
SPECIFIER
QUANTITY
DATE

## ZOE VINCENT 3 LIGHT LINEAR SUSPENSION

### D141250-

base number                      Finish  
Options

- To build a product code in our configurator select the specify button on the base model # product page
- To build a manual product code on this datasheet choose from the options listed below in blue font and add the suffix to the base model #

#### GENERAL

Series: Zoe  
Subseries: Zoe Vincent 3 Light Linear  
Partner: Cangini & Tucci  
Division: Design  
Installation: Suspension  
Product Type: Pendant  
Mounting Location: Ceiling

#### PHYSICAL

Shape: Teardrop  
Length (mm): 1200  
Length (in): 47 ¼  
Height (mm): 280  
Height (in): 11  
Max. Overall Height (mm): 1780  
Max. Overall Height (in): 70 ⅞  
Weight (kg): 5.59  
Weight (lbs): 12.32  
Diffuser: Glass - Opal  
Fixture Finish: [MSB / MBS / TRS](#)  
Holder Finish: BLK  
Fixture Material: Glass / Metal  
Primary Material: Glass - Borosilicate  
Cable Details: 1500mm cable

#### ELECTRICAL

Number of Lamps: 3  
Lamp Type: LED Retrofit  
Lamp Shape: A19  
Bulb Included: Bulb Not Included  
Total Output Wattage (W): 48  
Max. Wattage Per Lamp (W): 16  
Lamp Base: E26  
Input Voltage (V): 120  
Upon Request: 277Vac / GU24

#### LED

#### OPTICAL

#### RATINGS AND CERTIFICATIONS

Certified By: Certified for North American Standards  
IP rating: IP20

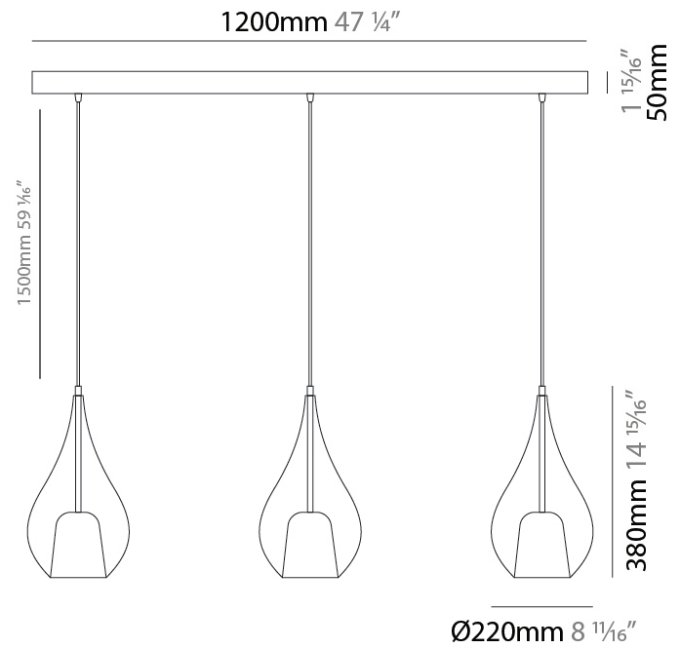

## ZOE VINCENT 3 LIGHT LINEAR SUSPENSION

D141250-

PROJECT	_____
TYPE	_____
SPECIFIER	_____
QUANTITY	_____
DATE	_____

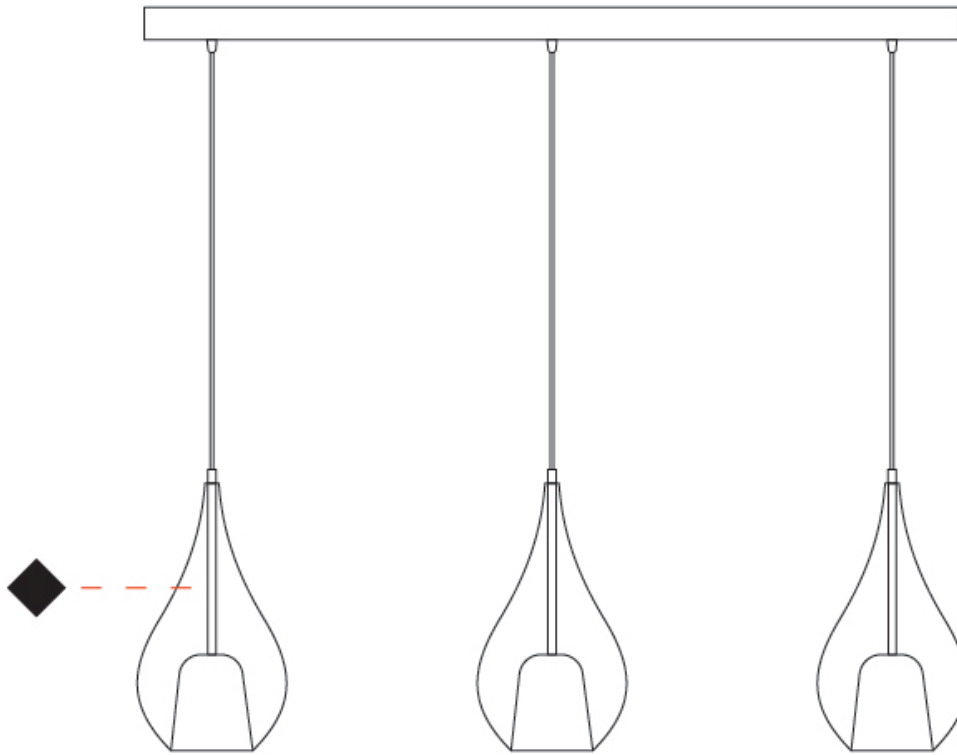

D

## ZOE VINCENT 3 LIGHT CLUSTER SUSPENSION

### D141251-

base number                      Finish                       
Options                     

- To build a product code in our configurator select the specify button on the base model # product page
- To build a manual product code on this datasheet choose from the options listed below in blue font and add the suffix to the base model #

#### GENERAL

Series: Zoe                       
Subseries: Zoe Vincent 3 Light Cluster                       
Partner: Cangini & Tucci                       
Division: Design                       
Installation: Suspension                       
Product Type: Pendant                       
Mounting Location: Ceiling                     

#### PHYSICAL

Shape: Teardrop                       
Diameter (mm): 430                       
Diameter (in): 16 <sup>15</sup>/<sub>16</sub>                       
Height (mm): 1500                       
Height (in): 59 <sup>15</sup>/<sub>16</sub>                       
Weight (kg): 6.48                       
Weight (lbs): 14.29                       
Diffuser: Glass - Opal                       
Fixture Finish: MSB / MBS / TRS                       
Holder Finish: BLK                       
Fixture Material: Glass / Metal                       
Primary Material: Glass - Borosilicate                       
Cable Details: 1500mm cable                     

#### ELECTRICAL

Number of Lamps: 3                       
Lamp Type: LED Retrofit                       
Bulb Included: Bulb Not Included                       
Total Output Wattage (W): 37                       
Max. Wattage Per Lamp (W): 16 + 5                       
Lamp Base: E26 + G9                       
Input Voltage (V): 120                     

#### LED

#### OPTICAL

#### RATINGS AND CERTIFICATIONS

Certified By: Certified for North American Standards                       
IP rating: IP20                     

PROJECT	_____
TYPE	_____
SPECIFIER	_____
QUANTITY	_____
DATE	_____

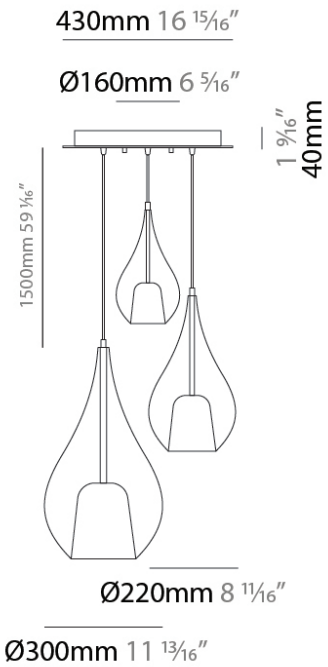

## ZOE VINCENT 3 LIGHT CLUSTER SUSPENSION

D141251-

PROJECT

TYPE

SPECIFIER

QUANTITY

DATE

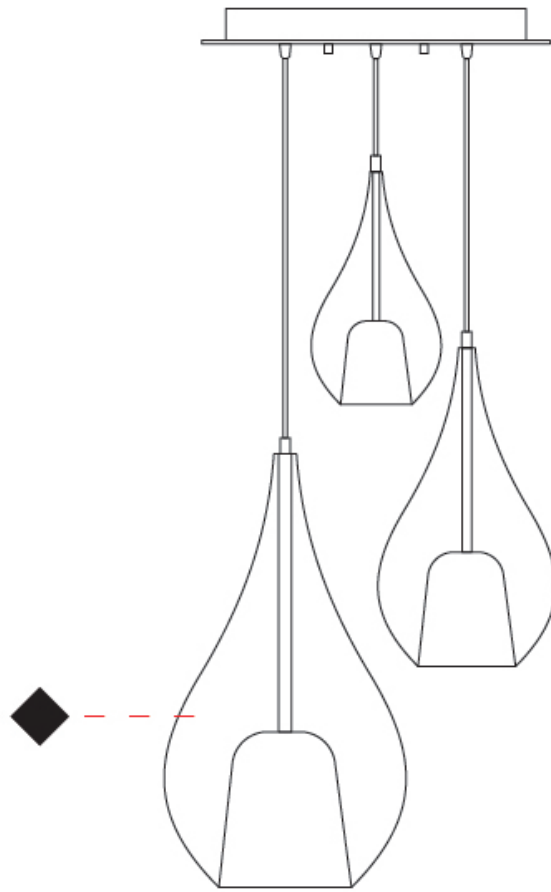

D

## ZOE MAX SUSPENSION

**D141268-** \_\_\_\_\_ - \_\_\_\_\_

base number      Finish      Finish  
Options            Options      Options

- To build a product code in our configurator select the specify button on the base model # product page
- To build a manual product code on this datasheet choose from the options listed below in blue font and add the suffix to the base model #

### GENERAL

Series: Zoe  
Subseries: Zoe Max  
Partner: Cangini & Tucci  
Division: Design  
Installation: Suspension  
Product Type: Pendant  
Mounting Location: Ceiling

### PHYSICAL

Shape: Teardrop  
Diameter (mm): 450  
Diameter (in): 17 ¾  
Height (mm): 800  
Height (in): 31 ½  
Max. Overall Height (mm): 2300  
Max. Overall Height (in): 90 ½  
Weight (kg): 7.80  
Weight (lbs): 17.19  
Diffuser: Glass - Opal  
Fixture Finish: [AMB / GRN / BRZ / PNK / RUB / SKB / SMK / TOB / TRA / GLD / BLK](#)  
Holder Finish: CHR / MWH / MBK / BCR  
Fixture Material: Glass / Metal  
Primary Material: Glass - Borosilicate  
Cable Details: 1500mm Cable

### ELECTRICAL

Number of Lamps: 1  
Lamp Type: LED Retrofit  
Lamp Shape: A19  
Bulb Included: Bulb Not Included  
Max. Wattage Per Lamp (W): 25  
Lamp Base: E26  
Input Voltage (V): 120  
Upon Request: 277Vac / GU24

### LED

### OPTICAL

### RATINGS AND CERTIFICATIONS

Certified By: Certified for North American Standards  
IP rating: IP20

PROJECT
TYPE
SPECIFIER
QUANTITY
DATE

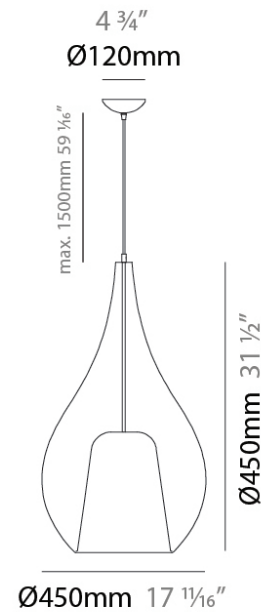

D141268-

PROJECT

TYPE

SPECIFIER

QUANTITY

DATE

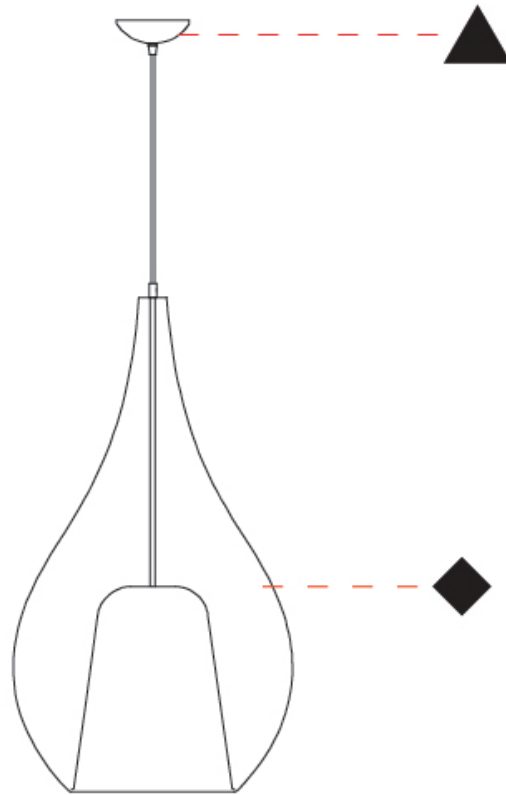

D

## ZOE SURFACE

### D143021-

base number      Finish      Finish  
Options              Options

- To build a product code in our configurator select the specify button on the base model # product page
- To build a manual product code on this datasheet choose from the options listed below in blue font and add the suffix to the base model #

#### GENERAL

Series: Zoe  
 Partner: Cangini & Tucci  
 Division: Design  
 Installation: Surface  
 Product Type: Wall Surface  
 Mounting Location: Wall

#### PHYSICAL

Shape: Teardrop  
 Diameter (mm): 160  
 Diameter (in): 6 <sup>5</sup>/<sub>16</sub>  
 Height (mm): 280  
 Depth (mm): 200  
 Height (in): 11  
 Depth (in): 7 <sup>7</sup>/<sub>8</sub>  
 Max. Overall Height (mm): 780  
 Max. Overall Height (in): 30 <sup>11</sup>/<sub>16</sub>  
 Extension (mm): 200  
 Extension (in): 7 78  
 Weight (kg): 0.875  
 Weight (lbs): 1.93  
 Diffuser: Glass - Opal  
 Fixture Finish: [AMB](#) / [BLK](#) / [BRZ](#) / [GLD](#) / [GRN](#) / [PNK](#) / [RUB](#) / [SKB](#) / [SMK](#) / [TOB](#) / [TRA](#)  
 Holder Finish: [CHR](#) / [MWH](#) / [MBK](#) / [BCR](#)  
 Fixture Material: Glass / Metal  
 Primary Material: Glass - Borosilicate

#### ELECTRICAL

Number of Lamps: 1  
 Lamp Type: LED Retrofit  
 Bulb Included: Bulb Not Included  
 Max. Wattage Per Lamp (W): 5  
 Lamp Base: G9  
 Input Voltage (V): 120

#### LED

#### OPTICAL

#### RATINGS AND CERTIFICATIONS

Certified By: Certified for North American Standards  
 IP rating: IP20

PROJECT
TYPE
SPECIFIER
QUANTITY
DATE

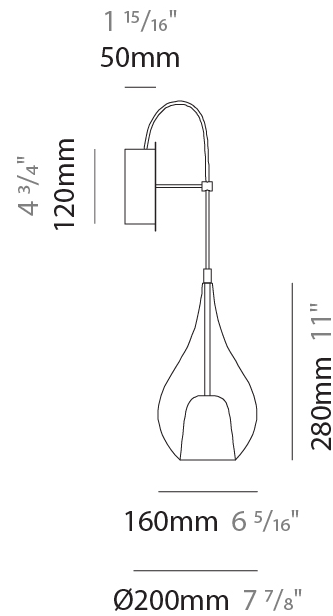

D143021-

PROJECT

TYPE

SPECIFIER

QUANTITY

DATE

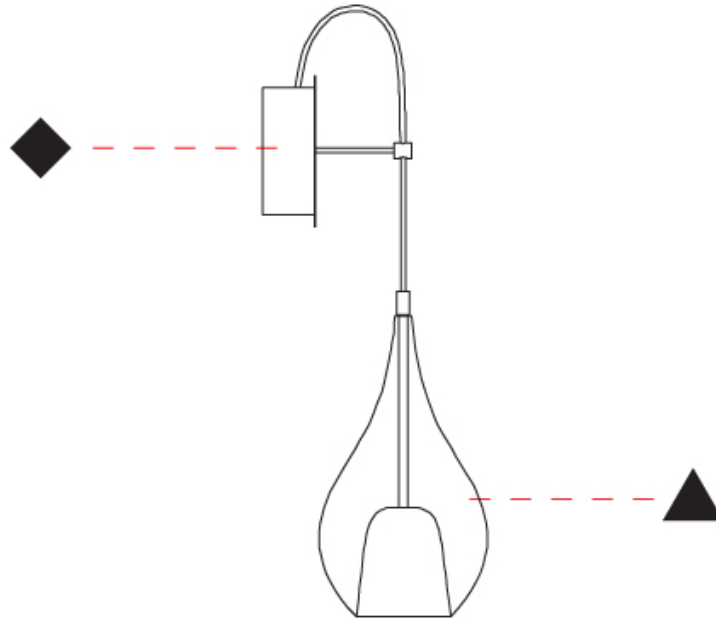

D

## ZOE VINCENT SURFACE

### D143032-

base number Finish  
Options

1. To build a product code in our configurator select the specify button on the base model # product page
2. To build a manual product code on this datasheet choose from the options listed below in blue font and add the suffix to the base model #

#### GENERAL

Series: Zoe  
 Subseries: Zoe Vincent  
 Partner: Cangani & Tucci  
 Division: Design  
 Installation: Surface  
 Product Type: Wall Surface  
 Mounting Location: Wall

#### PHYSICAL

Shape: Teardrop  
 Diameter (mm): 160  
 Diameter (in): 6 <sup>5</sup>/<sub>16</sub>  
 Height (mm): 280  
 Depth (mm): 200  
 Height (in): 11  
 Depth (in): 7 <sup>7</sup>/<sub>8</sub>  
 Max. Overall Height (mm): 780  
 Max. Overall Height (in): 30 <sup>11</sup>/<sub>16</sub>  
 Extension (mm): 200  
 Extension (in): 7 <sup>7</sup>/<sub>8</sub>  
 Weight (kg): 0.875  
 Weight (lbs): 1.93  
 Diffuser: Glass - Opal  
 Fixture Finish: [MSB](#) / [MBS](#) / [TRS](#)  
 Holder Finish: BLK  
 Fixture Material: Glass / Metal  
 Primary Material: Glass - Borosilicate

#### ELECTRICAL

Number of Lamps: 1  
 Lamp Type: LED Retrofit  
 Bulb Included: Bulb Not Included  
 Max. Wattage Per Lamp (W): 5  
 Lamp Base: G9  
 Input Voltage (V): 120

#### LED

#### OPTICAL

#### RATINGS AND CERTIFICATIONS

Certified By: Certified for North American Standards  
 IP rating: IP20

PROJECT
TYPE
SPECIFIER
QUANTITY
DATE

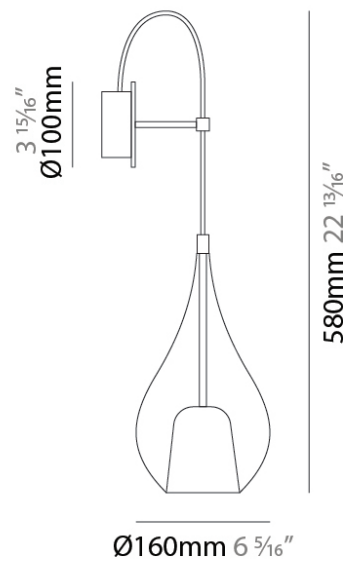

D143032-

PROJECT

TYPE

SPECIFIER

QUANTITY

DATE

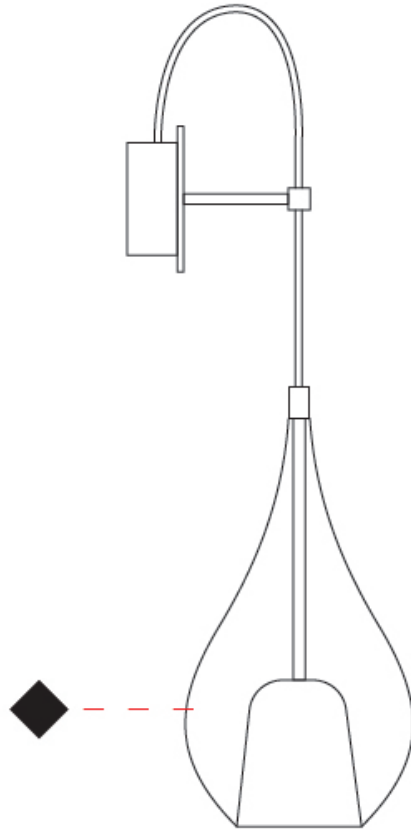

D

## ZOE VINCENT - PORTABLE PORTABLE

### D144028-

base number Finish  
Options

PROJECT
TYPE
SPECIFIER
QUANTITY
DATE

- To build a product code in our configurator select the specify button on the base model # product page
- To build a manual product code on this datasheet choose from the options listed below in blue font and add the suffix to the base model #

#### GENERAL

Series: Zoe  
 Subseries: Zoe Vincent - Portable  
 Partner: Cangani & Tucci  
 Division: Design  
 Installation: Portable  
 Product Type: Table  
 Mounting Location: Table

#### PHYSICAL

Shape: Teardrop  
 Diameter (mm): 250  
 Diameter (in): 9 <sup>13</sup>/<sub>16</sub>  
 Height (mm): 430  
 Height (in): 16 <sup>15</sup>/<sub>16</sub>  
 Weight (kg): 1.10  
 Weight (lbs): 2.43  
 Diffuser: Glass - Opal  
 Fixture Finish: MSB / TRA  
 Holder Finish: BLK  
 Fixture Material: Glass / Metal  
 Primary Material: Glass - Borosilicate

#### ELECTRICAL

Number of Lamps: 1  
 Lamp Type: LED + LED Retrofit  
 Input Wattage (W): 4.3  
 Bulb Included: Bulb Not Included  
 Max. Wattage Per Lamp (W): 3  
 Lamp Base: E12  
 Dimming: Non-Dimmable  
 Input Voltage (V): 120

#### LED

Number of LEDs: 1  
 Color Temperature (°K): 3000  
 Max. Delivered Lumen (lm): 350  
 Nominal Lumen (lm): 350

#### OPTICAL

#### RATINGS AND CERTIFICATIONS

Certified By: Certified for North American Standards  
 IP rating: IP20

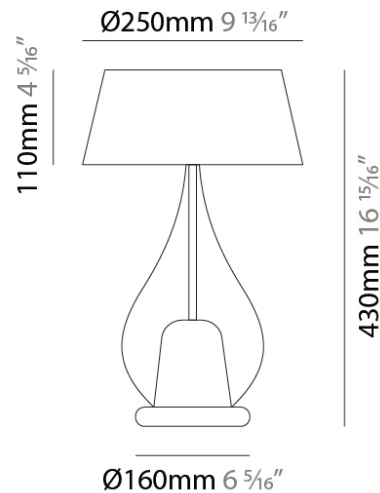

## ZOE VINCENT - PORTABLE PORTABLE

D144028-

PROJECT

TYPE

SPECIFIER

QUANTITY

DATE

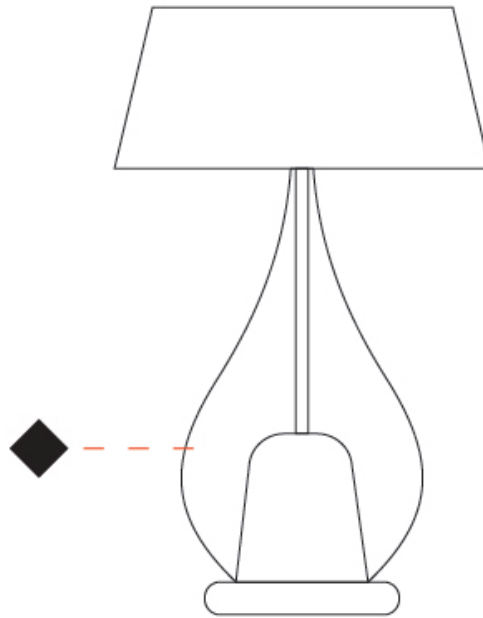

D

PROJECT
TYPE
SPECIFIER
QUANTITY
DATE

## ZOE VINCENT - PORTABLE PORTABLE

### D144029-

base number Finish  
Options

- To build a product code in our configurator select the specify button on the base model # product page
- To build a manual product code on this datasheet choose from the options listed below in blue font and add the suffix to the base model #

#### GENERAL

Series: Zoe  
 Subseries: Zoe Vincent - Portable  
 Partner: Cangini & Tucci  
 Division: Design  
 Installation: Portable  
 Product Type: Table  
 Mounting Location: Table

#### PHYSICAL

Shape: Teardrop  
 Diameter (mm): 400  
 Diameter (in): 15 3/4  
 Height (mm): 580  
 Height (in): 22 13/16  
 Weight (kg): 1.92  
 Weight (lbs): 4.23  
 Diffuser: Glass - Opal  
 Fixture Finish: MSB / TRA  
 Holder Finish: BLK  
 Fixture Material: Glass / Metal  
 Primary Material: Glass - Borosilicate

#### ELECTRICAL

Number of Lamps: 1  
 Lamp Type: LED + LED Retrofit  
 Input Wattage (W): 4.3  
 Bulb Included: Bulb Not Included  
 Max. Wattage Per Lamp (W): 8  
 Lamp Base: E26  
 Dimming: Non-Dimmable  
 Input Voltage (V): 120

#### LED

Number of LEDs: 1  
 Color Temperature (°K): 3000  
 Max. Delivered Lumen (lm): 350  
 Nominal Lumen (lm): 350

#### OPTICAL

#### RATINGS AND CERTIFICATIONS

Certified By: Certified for North American Standards  
 IP rating: IP20

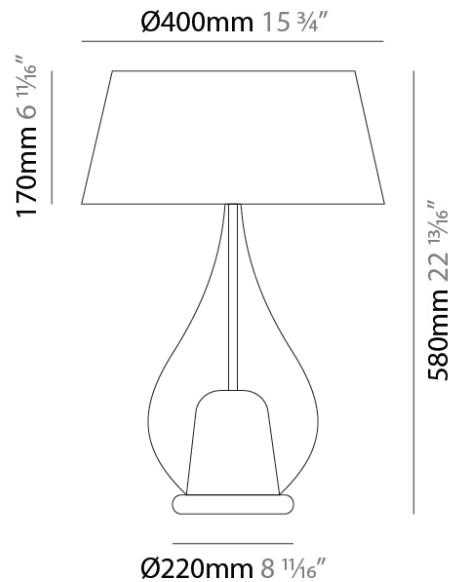

## ZOE VINCENT - PORTABLE PORTABLE

D144029-

PROJECT

TYPE

SPECIFIER

QUANTITY

DATE

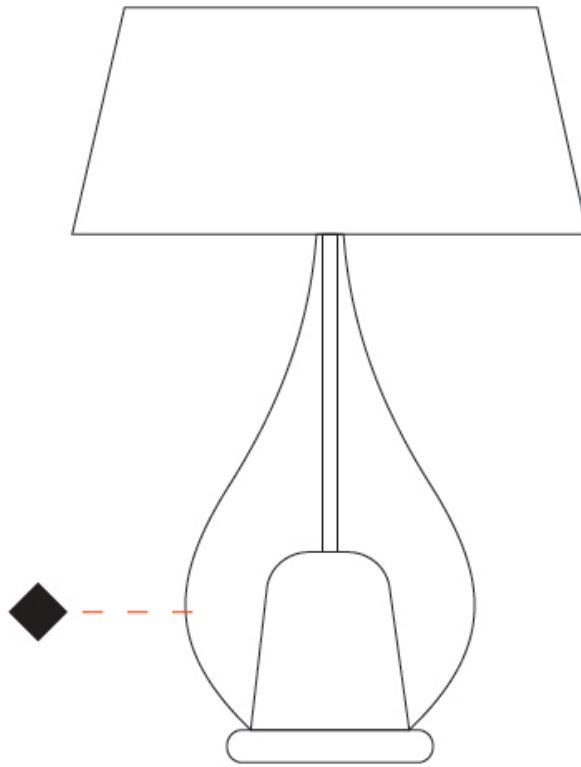

D

PROJECT	_____
TYPE	_____
SPECIFIER	_____
QUANTITY	_____
DATE	_____

## ZOE VINCENT - PORTABLE PORTABLE

### D144030-

base number            Finish             
Options           

- To build a product code in our configurator select the specify button on the base model # product page
- To build a manual product code on this datasheet choose from the options listed below in blue font and add the suffix to the base model #

#### GENERAL

Series: Zoe  
 Subseries: Zoe Vincent - Portable  
 Partner: Cangani & Tucci  
 Division: Design  
 Installation: Portable  
 Product Type: Table  
 Mounting Location: Table

#### PHYSICAL

Shape: Teardrop  
 Diameter (mm): 500  
 Diameter (in): 19 11/16  
 Height (mm): 780  
 Height (in): 30 11/16  
 Weight (kg): 3.435  
 Weight (lbs): 7.57  
 Diffuser: Glass - Opal  
 Fixture Finish: MSB / TRA  
 Holder Finish: BLK  
 Fixture Material: Glass / Metal  
 Primary Material: Glass - Borosilicate

#### ELECTRICAL

Number of Lamps: 1  
 Lamp Type: LED + LED Retrofit  
 Input Wattage (W): 4.3  
 Bulb Included: Bulb Not Included  
 Max. Wattage Per Lamp (W): 8  
 Lamp Base: E26  
 Dimming: Non-Dimmable  
 Input Voltage (V): 120

#### LED

Number of LEDs: 1  
 Color Temperature (°K): 3000  
 Max. Delivered Lumen (lm): 350  
 Nominal Lumen (lm): 350

#### OPTICAL

#### RATINGS AND CERTIFICATIONS

Certified By: Certified for North American Standards  
 IP rating: IP20

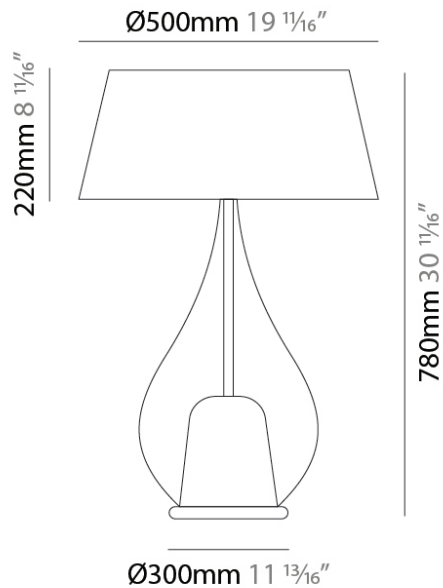

## ZOE VINCENT - PORTABLE PORTABLE

D144030-

PROJECT

TYPE

SPECIFIER

QUANTITY

DATE

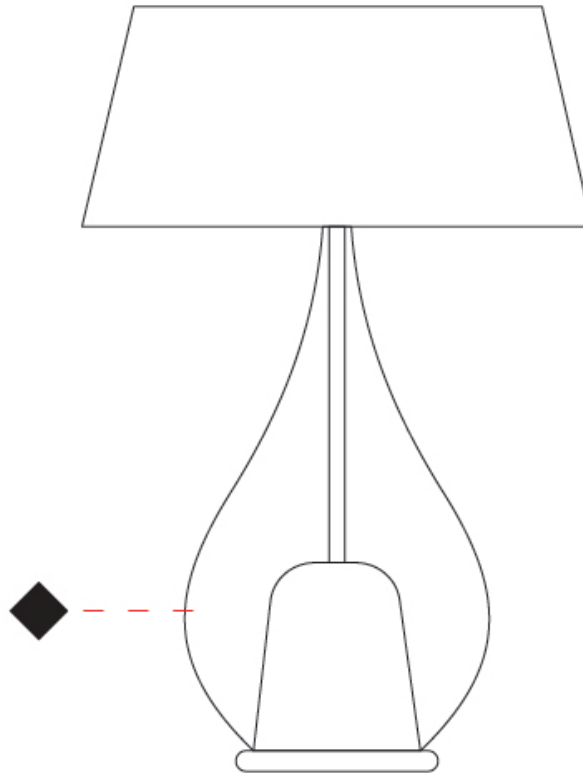

D

PROJECT
TYPE
SPECIFIER
QUANTITY
DATE

### Fixture Finish

Amber - AMB



Black - BLK



Bronze - BRZ

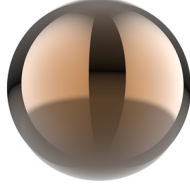

Gold - GLD

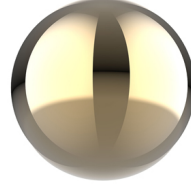

Green - GRN



Pink - PNK



Ruby - RUB



Sky Blue - SKB



Smoke - SMK



Tobacco - TOB



Transparent - TRA



### Holder Finish

Black - BLK



Chrome - CHR



Matte White - MWH

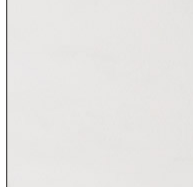

Matte Black - MBK

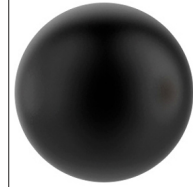

Brushed Chrome - BCR

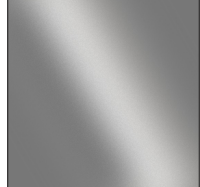

**Digital:** Not all screens are calibrated the same, and therefore, colors will appear differently between screens.  
**Physical:** When texture is involved, there will be variations in color, character and tone within a product series and between product families.

### LEGEND

	floor-mounted		pivotal		special LED (upon request) RGB, RGBW, tunable, gold+, meat+, art+, fashion+
	wall and ceiling: recessed and surface mounted		rotating		warm dim / natural dimming LED
	ceiling-mounted and wall-mounted		illuminate tilted		rechargeable battery powered
	wall-mounted		color of suspension cable		fixture with natural vivid LED (upon request)
	omni-directional light distribution		length of suspension cable		color rendering index
	direct light distribution		reflector degree selection		color temperature
	direct/indirect light distribution		super spot		lumen (luminous flux)
	indirect light distribution		lens		efficacy (lumens per watt)
	asymmetric light distribution		lens pack		Unified Glare Rating (UGR) range from 5-40
	aura light distribution		shine ring		marine grade (AISI 316 stainless steel)
	round wall or ceiling cut-out		integrated shine ring with diffuser		walk on
	square wall or ceiling cut-out		free individual colors 01-29		drive on
	the supplied jig specifies the cutout dimensions		individual colors: 00 (free of charge), 01-25 (extra charge)		Dark Sky Compliance
	minimum distance (meters) lamp - object		luminaire part to be colored (F1)		Americans with Disabilities Act (less than 4" off the wall located between 27"-84" from floor)
	recessed depth		luminaire part to be colored (F2)		lamp protected against explosion
	ceiling thickness in mm		luminaire part to be colored (F3)		blown glass using traditional methods by master glass blower
	ceiling thickness selection		luminaire part to be colored (F4)		acoustic material
	dimmable DP (phase), DV (0-10V), DD (dali), DS (step-dim)		luminaire part to be colored (F5)		protection class I, protection insulation
	included or excluded LED driver/transformer/control gear		color of 3-circuit adaptor		protection class II, protection insulation
	separately switchable		indirect diffuser		ETL Certified to UL and CSA Standards
	sensor		direct diffuser		UL Certified to UL and CSA Standards
	remote control		ball-proof (upon request)		CSA Certified to UL and CSA Standards
	available upon request		accessory		Certified for North American Standards

### IP RATING

	protected against ingress of solid bodies greater than 12.5mm (finger)
	protected against ingress of solid bodies greater than 2.5mm protected against sprays of water up to 60 degrees from the vertical (rain)
	protected against ingress of solid bodies greater than 1mm (wire) no protection against the ingress of moisture
	protected against ingress of solid bodies greater than 1mm (wire) protected against sprays of water up to 60 degrees from the vertical (rain)
	protected against ingress of solid bodies greater than 1mm (wire) protected against water splashed from all directions
	protected against limited ingress of dust (wet rooms/covered outdoor areas) protected against water splashed from all directions
	protected against ingress of dust protected against jets of water
	protected against ingress of dust protected against powerful jets of water or heavy seas
	protected against ingress of dust protected against immersion of water between 15cm - 1m for 30 minutes
	protected against ingress of dust protected against immersion of water under pressure for long periods

### IK RATING

	protected against 0.14 joules impact (equivalent to 0.25kg mass dropped from 56mm above the surface)
	protected against 0.2 joules impact (equivalent to 0.25kg mass dropped from 80mm above the surface)
	protected against 0.35 joules impact (equivalent to 0.25kg mass dropped from 140mm above the surface)
	protected against 0.5 joules impact (equivalent to 0.25kg mass dropped from 200mm above the surface)
	protected against 0.7 joules impact (equivalent to 0.25kg mass dropped from 280mm above the surface)
	protected against 1 joules impact (equivalent to 0.25kg mass dropped from 400mm above the surface)
	protected against 2 joules impact (equivalent to 0.5kg mass dropped from 400mm above the surface)
	protected against 5 joules impact (equivalent to 1.7kg mass dropped from 300mm above the surface)
	protected against 10 joules impact (equivalent to 5.0kg mass dropped from 200mm above the surface)
	protected against 20 joules impact (equivalent to 5.0kg mass dropped from 400mm above the surface)